

Fundamentals

of Small Parts Resistance Welding

General Principles

Resistance welding is a thermo-electric process in which heat is generated at the interface of the parts to be joined by passing an electrical current through the parts for a precisely controlled time and under a controlled pressure (also called force). The name "resistance" welding derives from the fact that the resistance of the workpieces and electrodes are used in combination or contrast to generate the heat at their interface.

Key advantages of the resistance welding process include:

- Very short process time
- No consumables, such as brazing materials, solder, or welding rods
- Operator safety because of low voltage
- Clean and environmentally friendly
- A reliable electro-mechanical joint is formed

Resistance welding is a fairly simple heat generation process: the passage of current through a resistance generates heat. This is the same principle used in the operation of heating coils. In addition to the bulk resistances, the contact resistances also play a major role. The contact resistances are influenced by the surface condition (surface roughness, cleanliness, oxidation, and platings).

The general heat generation formula for resistance welding is:

$$\text{Heat} = I^2 \times R \times t \times K$$

Where "I" is the weld current through the workpieces, "R" is the electrical resistance (in ohms) of the workpieces, "t" is the weld time (in hertz, milliseconds or microseconds), and "K" is a thermal constant. The weld current (I) and duration of current (t) are controlled by the resistance welding power supply. The resistance of the workpieces (R) is a function of the weld force and the materials used. The thermal constant "K" can be affected by part geometry, fixturing and weld force.

The bulk and contact resistance values of the workpieces, electrodes, and their interfaces both cause and affect the amount of heat gen-

erated. The diagram (above right) illustrates three contact and four bulk resistance values, which, combined, help determine the heat generated.

BULK RESISTANCE is a function of temperature. All metals exhibit a Positive Temperature Coefficient (PTC), which means that their bulk resistance increases with temperature. Bulk resistance becomes a factor in longer welds.

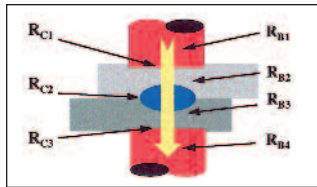

CONTACT RESISTANCE is a function of the extent to which two surfaces mate intimately or come in contact. Contact resistance is an important factor in the first few milliseconds of a weld.

The surfaces of metal are quite rough if they are examined on a molecular scale. When the metals are forced together with a relatively small amount of force, some of the peaks make contact.

On those peaks where the contact pressure is sufficiently high, the oxide layer breaks, forming a limited number of metal-to-metal bridges. The weld current is distributed over a large area as it passes through the bulk metal. However, as it approaches the interface, the current is forced to flow through these metallic bridges. This "necking down" increases the current density, generating enough heat to cause melting. As the first of these bridges melt and collapse, new peaks come into contact, forming new bridges and additional current paths. The resistance of the molten metal is higher than that of the new bridges so that the current flow transfers from bridge-to-bridge. This process continues until the entire interface is molten. When the current stops, the electrodes rapidly cool the molten metal, which solidifies, forming a weld.

Exaggerated cross-section of two pieces of metal indicates formation of metallic bridges that result in high current density.

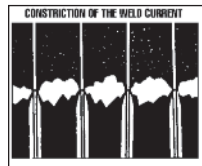

Subsequent melting and the formation of new bridges allow the weld to be formed.

HEAT BALANCE – During resistance welding, part of the heat generated is lost to the surroundings by conduction (heat transfer through solids), convection (heat lost from exposed surfaces by air-cooling), and radiation (does not require a medium). Heat balance is a function of part material and geometry, electrode material and geometry, polarity, and the weld schedule. The goal of good resistance welding is to focus the heat generated close to the weld interface at the spot where the weld is desired.

In general, the highest resistance results in the highest heat assuming that the resistance welding power supply can produce sufficient energy to overcome the resistance. Thus, dissimilar parts and electrode combinations are preferred since their dissimilarity results in higher resistance. For example, conductive electrodes, e.g. copper, are used to weld resistive materials such as stainless steel or nickel, and resistive electrodes, e.g. molybdenum, are used to weld conductive materials, such as copper or gold.

To force the metals together, electrode pressure (force) provided by the weld head, is equally important. Heat, generated by the resistance of the workpieces to the flow of electricity, either melts the material at the interface or reduces its strength to a level where the surface becomes plastic. When the flow of current stops, the electrode force is maintained, for a fraction of a second, while the weld rapidly cools and solidifies.

There are three basic types of resistance welding bonds:

SOLID STATE BOND – In a Solid State Bond (also called thermo-compression Bond), dissimilar materials with dissimilar grain structure, e.g. molybdenum to tungsten, are joined using a very short heating time, high weld energy, and high force. There is little melting and minimum grain growth, but a definite bond and grain interface. Thus the materials actually bond while still in the "solid state." The bonded materials typically exhibit excellent shear and tensile strength, but poor peel strength.

FUSION BOND – In a Fusion Bond, either similar or dissimilar materials with similar grain structures are heated to the melting point (liquid state) of both. The subsequent cooling and combination of the materials forms a “nugget” alloy of the two materials with larger grain growth. Typically, high weld energies at either short or long weld times, depending on physical characteristics, are used to produce fusion bonds. The bonded materials usually exhibit excellent tensile, peel and shear strengths.

REFLOW BRAZE BOND – In a Reflow Braze Bond, a resistance heating of a low temperature brazing material, such as gold or solder, is used to join either dissimilar materials or widely varied thick/thin material combinations. The brazing material must “wet” to each part and possess a lower melting point than the two workpieces. The resultant bond has definite interfaces with minimum grain growth. Typically the process requires a longer (2 to 100 ms) heating time at low weld energy. The resultant bond exhibits excellent tensile strength, but poor peel and shear strength.

HEAT AFFECTED ZONE (HAZ) is the volume of material at or near the weld which properties have been altered due to the weld heat. Since the resistance welding process relies on heating two parts, some amount of HAZ is inevitable. The material within the HAZ undergoes a change, which may or may not be beneficial to the welded joint. In general, the goal in good resistance welding is to minimize the HAZ.



Solid State Bond



Fusion Bond

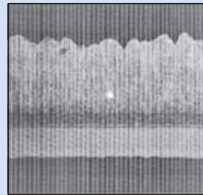

Reflow Braze Bond

Materials

The physical metallurgy of the materials to be welded determines the application of the resistance welding process variables. In general there are two categories of metals to be welded: “Conductive” (such as aluminum, copper, silver and gold), and “Resistive” (steel, nickel, inconel, titanium, tungsten, molybdenum) with a third, small, middle ground category occupied primarily by brass. In general, electrically conductive materials are also more thermally conductive and are softer.

These categories apply equally to both the workpieces to be joined and to the electrodes. As discussed earlier, higher electrical resistance produces higher heat and better welds. Thus the “rule of opposites” applies to matching electrodes to workpieces to be welded. The general rule (with a few exceptions such as aluminum and beryllium copper) is to utilize conductive electrodes against resistive parts and resistive electrodes against conductive parts. By extension, when welding dissimilar materials, the upper and lower (or anode and cathode) electrodes must be of different materials to each other in order to apply the “rule of opposites.”

When welding a resistive material to a conductive material, one should use conductive electrodes (copper) on resistive parts (steel) and resistive electrodes (moly) on conductive parts (copper).

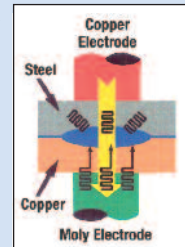

Material Properties

ELECTRICAL RESISTIVITY – Low resistance metals, e.g. copper, require larger currents to produce the same amount of heat. Low resistance materials also exhibit low contact resistance.

THERMAL CONDUCTIVITY – Metals with high thermal conductivity, e.g. copper, exhibit high electrical conductivity. The heat generated in high thermal conductivity materials is rapidly conducted away from the region of the weld. For metallic materials, the electrical and thermal conductivity correlate positively, i.e. materials with high electrical conductivity (low electrical resistance) exhibit high thermal conductivity.

THERMAL EXPANSION – Softer metals exhibit a high coefficient of expansion (CTE); whereas harder materials, such as tungsten, exhibit a low CTE. A CTE mismatch between two workpieces can result in significant residual stresses at the joint which, when combined with the applied stresses, can cause failure at lower pull strengths.

HARDNESS AND STRENGTH – In seeming contradiction to the “rule of opposites,” hard material workpieces generally require harder electrodes (which exhibit lower conductivity) due to the higher weld forces required.

PLASTIC TEMPERATURE RANGE is the temperature range in which a material can be de-

formed easily (melt) under the application of force. Steels and alloys exhibit a wide plastic temperature range and thus are easy to fusion weld. The natural elements, copper and aluminum exhibit a narrow plastic temperature range. Accurate control of the weld temperature is critical to avoid excessive melting.

POLARITY should be considered when using all power supply technologies. If any of the interfaces of a resistance weld (between electrodes and workpieces or between the workpieces to be joined) is composed of dissimilar materials, that interface will heat or cool depending on the polarity of the applied potential. This effect is dominant only in the first few milliseconds of a weld. Although it is more dominant for welds of short duration, it affects the weld quality and electrode wear of long welds as well. The effects of polarity can be minimized or controlled via the use of contrasting size electrode forces and/or weld pulses of alternating polarity.

Other material related parameters affect the resistance welding process, and must therefore be controlled. These parameters include oxide contamination, plating inconsistencies, surface roughness and heat imbalance.

OXIDE CONTAMINATION causes inconsistent welds by inhibiting intimate contact at the weld joint. Preventive actions include pre-cleaning

the workpieces, increasing the weld force to push aside the oxide, and/or using a cover gas during welding to prevent additional oxide formation.

PLATING INCONSISTENCIES include variations in plating thickness, degree of oxide contamination in the plating and the type of plating. Proper control of workpiece plating reduces the chance of weak or inconsistent welds and/or electrode sparking or sticking to the workpieces. Electroplating is much preferred over electroless plating.

SURFACE ROUGHNESS can also result in localized over/under heating, electrode sticking and/or material expulsion. The same rule applies to all three material parameters: any surface condition that impairs intimate workpiece contact to each other and to the electrodes will inhibit good welding.

HEAT IMBALANCE and heat sinks can result in unexpected heat loss or misdirection. Heat must be concentrated at the point of the weld to insure correct and consistent welds.

PROJECTIONS (low thermal mass islands) are one method of insuring proper heat balance in difficult applications when there exists a 5:1 size difference between the parts to be welded. Another method is to vary the size, shape and/or material of the welding electrode.

Advantages of Projections in Micro Spot Welding

By providing a projection on the surface of one of the workpieces, the current and force can be focused into the small area of the projection to produce heat at the desired weld location. Projection welding can also extend electrode life by increasing the electrode contact area and decreasing the current density at the surface of the electrode. Projection welding is effective even if the weldments are thick.

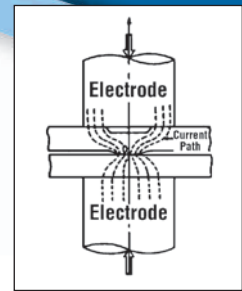

Basic Weld Schedule

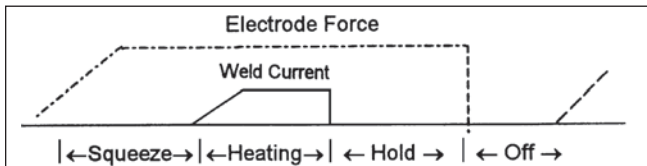

This basic weld schedule forms the basis for all microwelding schedules. The amplitude and duration of all force and heating parameters can be defined in the “weld schedule.” The four critical parameters are: electrode force, squeeze time, weld pulse and hold time. Variations can also be dual pulse and other sequences shown below.

Examples of welding sequences (also called heat profiles) include:



*Single Pulse:
Use on flat un-
plated parts*

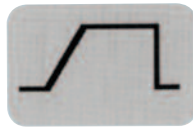

*Up Slope: Use on hard,
irregular shaped,
oxidized parts and
aluminum parts*

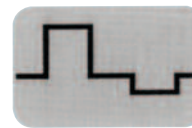

*Preheat/Postheat:
Use on refractive
parts*



*Quench/
Temper*



*Down Slope:
Used to reduce
marking and
embrittlement*

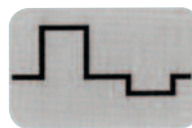

*Unbalanced:
Use on polarity
sensitive parts*



*Roll Spot: Use
to make
non-hermetic
seam welds*

Weld Force

A key parameter of all three types of resistance welding is weld pressure or force. The proper and consistent application of force improves the mating of the materials increasing the current paths, reducing the interface resistance, and insuring that any oxide barriers between the workpieces are broken through. Repeatable force control insures repeatable weld quality through consistent electrical contact resistance and consistent heat balance. Force control can also be used to trigger welding energy when a pre-determined force level has been achieved, often called “force firing.” Optimum welds are achieved when the applied force is precise, repeatable, controlled by time schedule, used to fire the power supply, and regulated both to reduce the initial impact and not to become excessive after the weld. **Weld force control is equally as important as weld energy and time control.**

Energy and Time

The power supply with either an internal or external transformer both powers and controls the application of heat and time in the resistance welding process. In general terms, resistance welding applies high current with low voltage.

The generic schematic is:

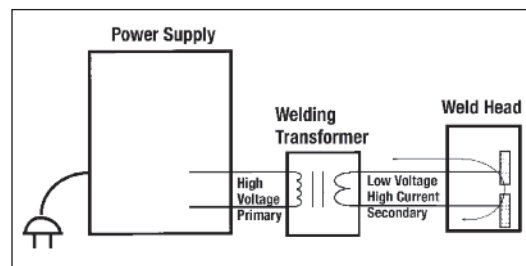

In simple terms the resistance welding power supply transforms, modulates and controls the electrical energy of the power line and applies it to the weld according to a user defined or user programmed “weld schedule.” Depending on the complexity and intricacy of the power supply the user can program from one to more than 100 attributes and permutations of the welding process, and, using a microprocessor, store these attributes as a uniquely defined “weld schedule.”

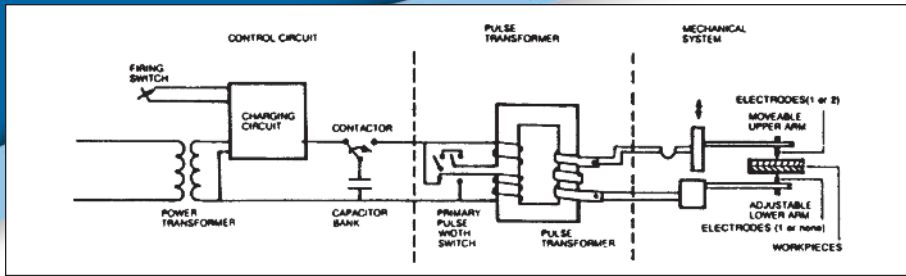

Functional Diagram of a Stored Energy Resistance Welding Machine

Stored Energy (Capacitive Discharge):

The stored energy welding power supply, commonly called a Capacitive Discharge or CD Welder, extracts energy from the power line over a period of time and stores it in welding capacitors. Thus, the effective weld energy is independent of line voltage fluctuations. This stored energy is rapidly discharged through a pulse transformer producing a flow of electrical current through the welding head and workpieces.

Capacitive discharge power supplies are rated in accordance with the amount of energy they

store and the welding speed. The energy stored, expressed in watt-seconds (joules), is the product of one-half the capacitance of the capacitor bank and the square of the applied voltage. The energy delivered to the electrodes is considerably less than this value because of losses in the primary and secondary circuits.

Some power supplies provide a "Dual Pulse" feature which allows the use of two pulses to make a weld. The first pulse is generally used to displace surface oxides and plating, and the second pulse welds the base materials. This feature also reduces spitting.

Power Supply Technologies

PULSE TRANSFORMERS – are designed to carry high secondary currents, typically up to 10,000 amps. Welds made with a capacitive discharge system are generally accomplished with a single, very short weld pulse with a duration of from 1 to 16 milliseconds. This produces rapid heating that is localized at the welding interface. The length of the output pulse width can normally be modified by changing taps on the pulse transformer. Polarity switching is a convenience when the machine is used to weld a wide variety of polarity sensitive dissimilar metals.

In practical applications, the short pulse is used to weld copper and brass, which require fast heating; the medium pulse is used to weld nickel, steel and other resistive materials and the long pulse is also used to weld resistive materials and to reduce sparking and electrode sticking.

Direct Energy (AC)

The AC welder derives its name from the fact that its output is generally a sine wave of the same frequency as the power line. It extracts energy from the power line as the weld is being made. For this reason, the power line must be well regulated and capable of providing the necessary energy. Some AC welders (including all Miyachi Unitek AC welders) include a line voltage compensation feature to automatically adjust for power line fluctuations. In its simplest form, the AC welder consists of a welding transformer that steps down the line voltage (normally between 480 to 100 volts) to the welding voltage (typically 2 to 20 volts). The welding current that flows through the secondary of the transformer, and its connected load, is very high, ranging from 10 to more than 100,000 amps. The welding current is allowed to flow for very short periods of time, typically .001 to 2 seconds. AC welders can operate at rates up to 5-6 welds per second.

AC Welding Systems are generally composed of the three elements. The Welding Trans-

former, the Welding Control, and the Mechanical System.

WELDING TRANSFORMERS – are used in AC machines to change alternating current from the power line into a low-voltage, high amperage current in the secondary winding. A combination of primary and/or secondary taps on the welding transformer are commonly used to provide a macro adjustment of the welding current, as well as adjustment of secondary voltage. Transformer ratings for AC machines are expressed in KVA (kilovolt-amperes) for a specified duty cycle. This duty cycle rating is a thermal rating, and indicates the amount of energy that the transformer can deliver for a stated percentage of a

specific time period, usually one minute, without exceeding its temperature rating. The RMS Short Circuit Secondary Current specification indicates the maximum current that can be obtained from the transformer. Since heating is a function of the welding current, this parameter gives an indication of the thickness of the materials that can be welded.

Recent advances in AC welding technology have adapted constant current feedback control at the line frequency (50 or 60 Hz) which can be useful for welds longer than 5 cycles (82-100 milliseconds) by automatically adjusting the power supply parameters.

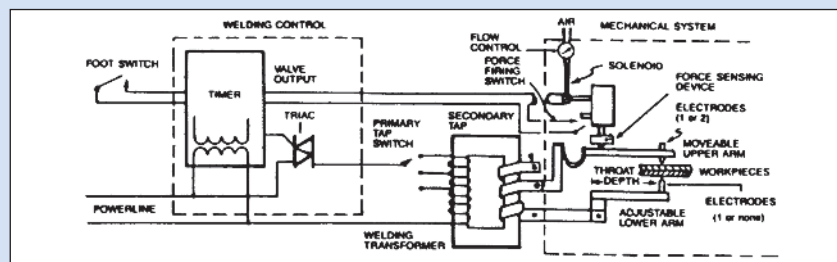

Functional Diagram of an AC Resistance Welding Machine

High Frequency Inverter (HFDC)

High Frequency Inverter Welders use submillisecond pulswidth modulation (switching) technology with closed-loop feedback to control the weld energy in submillisecond increments. Three phase

input current is full wave rectified to DC and switched at (up to) 25 kHz to produce an AC current at the primary of the welding transformer. The secondary current is then rectified to produce DC welding current with an imposed, low-level, AC ripple. The high-speed feedback circuitry enables the inverter power supply to adapt to changes in the secondary

loop resistance and the dynamics of the welding process. For example, a 25 kHz inverter power supply adjusts the output current every 20 microseconds after rectification, which also allows the weld time (duration of current) to be controlled accurately in increments as small as 0.1 milliseconds.

The high frequency closed loop feedback can be used to control (maintain constant) either current, voltage, or power while also monitoring another of the same three parameters.

Additional benefits of high frequency switching technology include reduced power consumption, smaller welding transformers, and the use of a very short pre-weld “check pulse” to test electrode and parts positioning prior to executing a weld. The result of this pre-weld check can be used to inhibit the weld by setting check limits.

CONSTANT CURRENT can be used for 65% of all welding applications including those that

exhibit low contact resistance, small variability in contact resistance, flat parts, and multiple part “sandwiches.”

CONSTANT VOLTAGE can be used for applications where the workpieces do not have flat surfaces, e.g. crossed wires, and where the resistance varies significantly, and for extremely short welds (less than 1 millisecond).

CONSTANT POWER can be used for applications with significant variations in electrical resistance from weld to weld, including applications where the plating erodes and builds-up on the face of the welding electrodes.

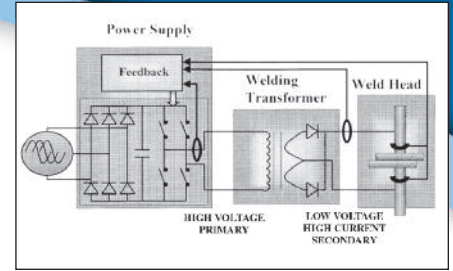

Functional Diagram of an HFDC Resistance Welding Machine

Due to their extensive programmability, small transformer size, and robustness, high frequency inverter power supplies are generally the best choice for automation applications.

Transistor Direct Current (Linear DC)

The transistor direct current power supplies (also called “Linear DC”) produce much the same results as the high frequency inverter by using a high number of power inverters as the direct energy source. This technology provides clean, square wave forms with extremely fast rise time. Used primarily in constant voltage feedback control, transistor DC power supplies are effective in thin foils and fine wire welding applications and for extremely short welds.

Linear DC welders utilize transistor controlled feedback enabling total feedback response times of less than 5 μS. The term Linear DC comes from the waveform that is output from the power supply. No transformer is utilized. The primary limitation to Linear DC technology is the low duty cycles, typically much less than 1 weld per second at less than rated output.

Typically, constant voltage feedback is utilized in conjunction with short weld

pulses. Because the feedback response is so rapid, high energy welds with extremely short duration can be used without weld splash or arcing. These short pulses limit the heat stress and the size of the heat affected zone on the weldments. This provides a stronger more ductile weld joint, along with less part deformation, less discoloration, and significantly longer electrode life.

Constant voltage feedback is chosen for two reasons: its ability to prevent arcing and to provide the optimum weld power distribution based on the part resistance. If for some reason the weldments collapse faster than the weld head can follow up, arcing usually occurs. When

constant voltage feedback is applied with the feedback response times capable by Linear DC welding this arcing is minimized.

Transistor DC units tend to be larger and heavier than other resistance welding power supply technologies.

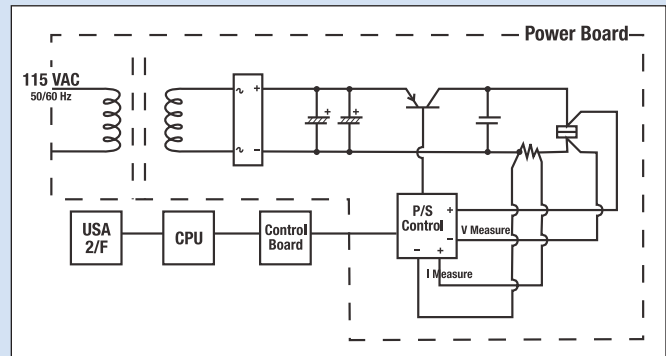

Functional Diagram of a Linear DC Resistance Welding Machine

Power Supply Technology Comparison

Power Supply	Typical Cycle Time	Typical Bond Type	Repetition Rate	Advantages	Limitations	Waveform
Capacitor Discharge (CD) provides a uni-polar fixed duration weld current pulse of short duration with a fast rise time.	1-16 msec	Solid State	≤ 2/sec.	Rugged and inexpensive. Suitable for highly conductive materials.	Open loop. Discharge “self-regulating.”	
Direct Energy (AC) provides a uni-polar or bi-polar, adjustable duration weld current pulse with rise times dependent on the % weld current setting.	>8 msec	Fusion, Reflow, Braze	≤ 5/sec.	Rugged and inexpensive.	Poor control at short cycle times.	
High Frequency Inverter (HFDC) provides a uni-polar, adjustable duration weld current pulse with an adjustable moderate-to-fast, rise time.	1,000 msec	Fusion, Solid State, Reflow, Braze	≤ 10/sec.	Excellent control and repeatability. High current capacity; high duty cycle.	Higher cost.	
Transistor or Linear DC (DC) provides a uni-polar, adjustable duration weld current pulse with a fast voltage rise time, and square voltage wave.	0.010 –9.99 msec	Solid State	≤ 1/sec.	Suitable for amorphous materials, thin foils, fine wires. Excellent control and repeatability.	Higher cost maintenance. Limited duty cycle. One piece construction.	

Weld Head Technologies

As described earlier, the application and control of force during the resistance welding process is extremely important. The mechanical system to do so is generally referred to as the weld head. The weld head (including the welding electrodes), functions to force the workpieces together and hold them during the weld. The weld head provides the current path, welding pressure or force, triggers (initiates) the weld current, provides follow-up force as the workpieces melt together, and cools the workpieces after the weld. Development of a weld head force schedule is equally as important as development of a power supply schedule. The ideal force schedule insures that proper electrical contact resistance and proper heat balance are both achieved and maintained between the workpieces and the electrodes. Force is measured in pounds (lbf), Kilograms (Kgf) or Newtons (N or dN).

In small parts resistance welding the weld heads are of linear motion design with linear races or bearings and spring-driven force adjustment. Low inertia weld heads with low mass electrode holders and low friction bearings provide fast "follow-up." "Follow-up" refers to the capacity of the weld head to accelerate and remain in contact with the workpieces as the workpieces become molten and melt together during the weld.

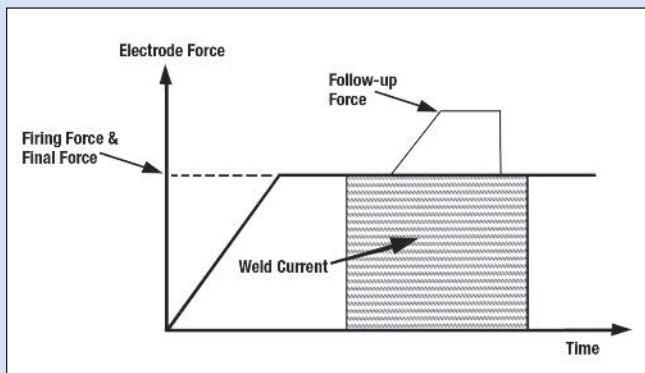

Recent advances in weld head design include electronic weld heads where weld head movement and force are electronically controlled, and/or electronically monitored, via a precise schedule. The precise control of an electronic weld head can program the timing of each element of the force profile, minimize impact force, duplicate force profile between weld stations, and provide electronic evidence of the actual

weld force profile. The control for electronic weld heads can be independent of, or integrated into, resistance welding power supplies. The "Electrode Force" diagram, below left, depicts the precisely controlled force profile, including follow-up force, of an electronic weld head.

Today, force sensors, strain gauges, and motion sensors/transducers can be built into a mechanical or electronic weld head for control and/or monitoring purposes. The weld head must be designed and operated to preclude these potential problems.

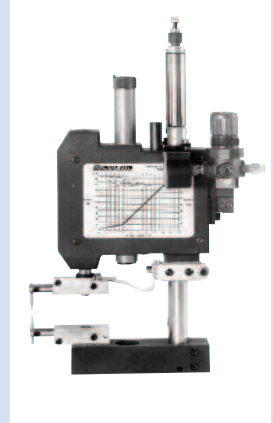

The most typical weld head related problems are depicted in the drawing below.

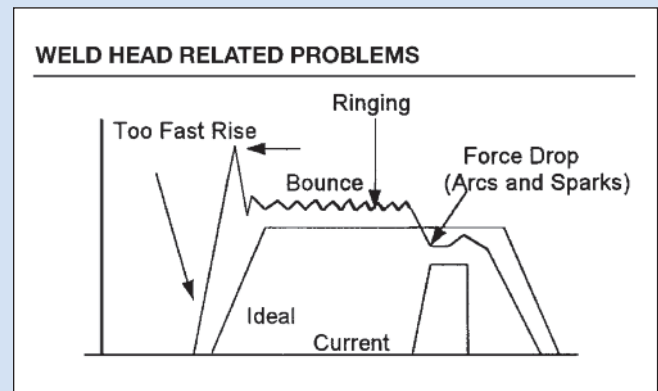

Lastly, the use of properly designed fixtures to hold the workpieces in fixed position during welding is highly desirable. The workpieces must be in a fixed rigid position prior to the initiation of the resistance welding process. In manual welding, operators should be used to load workpieces in a fixture, not to hold workpieces during the welding process. Additionally, the fixtures should be constructed to insure that the welding surface of the electrodes fit squarely and completely against the workpieces.

Welding Electrodes

Welding electrodes are installed in the weld head to touch and maintain contact with the workpieces through the full weld schedule. The MATERIALS section (pg. 2) discussed the "rule of opposites" and the criteria for selecting the electrode material.

The welding electrodes play three different roles in resistance welding: maintaining uniform current density, concentrating current at welding points, and maintaining thermal balance during welding. Electrodes are available in many shapes, with the most common shown at right. Electrode material and shape are determined by considering the force necessary for welding and the thermal conductivity of the workpieces.

In conventional macro-welding, e.g. car body assembly, the electrodes are made of copper alloys and usually water-cooled. However, in micro-welding, the electrodes are made of a wide variety of conductive and refractory materials depending on the parts to be joined, and are air-cooled.

Common Electrode Shapes:

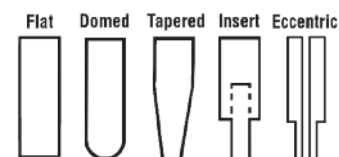

The size of the weld will not be larger than the electrode face. Therefore, it is important to utilize electrodes of the same tip diameter as the desired weld nugget. The current density at the workpiece interfaces varies as the square of the diameter of the electrode face. Electrode positioning is critical: electrodes

should be positioned where the weld is desired, should generally not overhang the edges of the part (except in wire and small terminal welding), should not bend, should be perpendicular to the plane of the workpieces, should maintain constant diameter (constant area) as they wear, and should be cleaned

and dressed regularly. Electrodes should be dressed with 600 grit silicon carbide paper or polishing disk pulled with light force in one direction only. Electrodes should be replaced when the tip is damaged or blows out. It is best to have all electrode tips reground regularly by a qualified machine shop.

The choice of electrode configurations is determined by the geometry of the workpieces, the application, and the desired current path.

The four basic electrode configurations are:

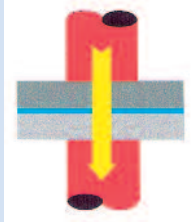

Opposed (Direct) Welding is the most commonly used type of resistance welding. The welding current flows directly from one electrode to the other, through the weldments.

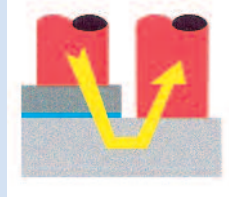

Step (Indirect) Welding is often used when the workpieces are configured in such a way that only one side of the workpiece is accessible with an electrode, or there is a large thermal imbalance. The welding current flows from the first electrode, through the workpiece, through the area of the weld, through the other workpiece and into the other electrode.

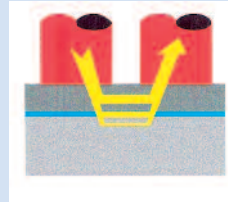

Series Welding is also used when only one side of the weldment is accessible with electrodes. This form of welding has the advantage of making two weld nuggets at one time. However, series welding is generally less controllable because of the many shunt paths available to the welding current.

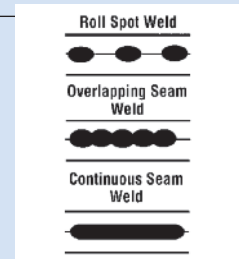

Seam Welding is another variation on resistance spot welding. In this case, the welding electrodes are motor-driven wheels rather than stationary rods. The result is a "rolling" resistance weld or seam weld used to join two sheets together. Overlapping and continuous seam welds can produce gas- or liquid- tight joints.

Common Electrode Materials

RWMA 1 – COPPER CADMIUM ALLOY – 70B Rockwell Hardness, 90% conductivity. Used for welding aluminum and tin plate. Not available from Miyachi Unitek. GLIDCOP is a substitute.

RWMA 2 – COPPER CHROMIUM ALLOY – 83B Rockwell Hardness, 85% conductivity. Used for welding steels, nickel alloys and other high resistance materials.

GLIDCOP – DISPERSION STRENGTHENED COPPER with 0.15% ALUMINUM OXIDE – 68B Rockwell Hardness, 92% conductivity. Longer

life, greater thermal stability, higher strength than RWMA 2. Generally interchangeable with RWMA 2 without changing schedules.

RWMA 3 – COPPER COBALT BERYLLIUM ALLOY – 100B Rockwell Hardness, 48% conductivity. Used for welding high resistance materials requiring high weld forces.

RWMA 11 – COPPER TUNGSTEN ALLOY – 99B Rockwell Hardness, 46% conductivity. Usually inserted into an RWMA 2 shank. Used for welding cuprous and precious metals. Used for

light projection welding dies.

RWMA 13 – TUNGSTEN – 70A Rockwell Hardness, 32% conductivity. Usually inserted into an RWMA 2 shank. Cannot be machined but may be ground to the desired shape. Used to weld non-ferrous metals such as copper and brass.

RWMA 14 – MOLYBDENUM – 90B Rockwell Hardness, 31% conductivity. Usually inserted into an RWMA 2 shank. Machineable. Used for welding copper, silver, gold and their alloys.

Weld Quality and Process Validation

The monitoring of any manufacturing process is essential for achieving the "six sigma" goals of production quality. Often the cost of monitoring equipment is significantly less expensive than the cost ramifications of the field failure of a single weld.

Destructive testing methods include tensile pull-test, peel tests, shear tests, corrosion tests, optical microscopy, cross-section inspection, and scanning electron microscopy. These tests are typically used to qualify processes initially as well as periodically. On-line monitoring

of key resistance welding parameters is a more effective method of continuous weld quality.

Weld monitors are devices that measure one or more specific electrical and/or mechanical parameters that dynamically change during the welding process. These measurements may include weld current, voltage drop across the electrodes, workpiece expansion and deformation, electrode force, electrode movement (displacement), size of the electrode face, acoustic energy emitted while the weld is being formed, and temperature of

the workpieces. Variations in the thickness, tensile strength, hardness, surface finish and cleanliness of the workpieces have a significant effect on weld quality. As discussed earlier, the shape of the electrode face also affects weld quality. Modern measurement techniques make it possible to accurately measure the energy and pressure used to make a resistance weld. Weld monitoring is effective to the extent that the electrical and mechanical measurements made during the welding process reflect the variations in the physical properties of the workpieces and the welding equipment.

Today's state-of-the-art resistance welding monitors can measure the following parameters practically and effectively:

- Current
- Voltage
- Force
- Displacement (weld collapse)

Combining these measurements in various ways can provide the user practical information regarding weld quality.

Pre-weld resistance checks can be used to detect the absence of parts or major irregularities in part thickness or fit-up.

Force monitoring can be used as a preventive measure to prevent excessive impact or weld force and as a diagnostic tool. Force monitoring

is generally used as a process control tool. It is used less often as a quality evaluation tool.

Extensive experiments are normally required in order to determine which combination of measurement parameters correlates with the quality of their specific parts. Once correlation is verified in a production environment over a reasonable time, the weld monitor becomes a vital manufacturing tool. If the user carefully controls the quality of the workpieces and uses good manufacturing process control, a weld monitor can provide the necessary electrical data for statistical process control which in turn should increase quality and reduce manufacturing costs.

Modern weld monitors integrate with or include

statistical process control (SPC) software. SPC software packages can perform statistical calculations, generate X-bar and R-control charts, and provide summary information of the weld data. A few monitors can compare multiple weld parameters for weld analysis.

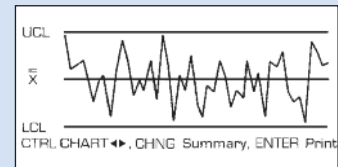
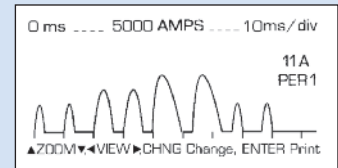

Process Validation

Studies by the Edison Welding Institute have shown the following probability ratio of causes of poor weld quality:

- 40% Fixture related
- 20% Weld head related
- 20% Part/electrode geometry
- 20% Weld schedule or power supply related

As with all good manufacturing practices, the welding process must be clearly defined, documented, and validated. The typical steps include:

1. Defining weld quality parameters:
 - Peel, tensile, or shear strength.
 - Part deformation allowable.
 - Nugget penetration and diameter.
 - Cosmetic requirement.
2. Optimizing the weld schedule.
3. Correlating welding and weld monitor with weld quality.
 - Peak weld current and electrode voltage.
 - Displacement (set-down).
 - Force.
 - Nugget diameter (if applicable).

- Nugget penetration.
 - Peel, tensile or shear strength.
 - Cosmetic acceptability.
4. Establishing process limits.
 5. Documenting weld schedule and monitor schedule.
 6. Auditing the weld schedule and weld process regularly.
 7. Establishing a regular equipment inspection and maintenance.

Weld documentation should address each of the following subjects:

- **Materials:**
 - Alloys
 - Dimensions
 - Surface Conditions
 - Projections, if applicable
- **Power Supply:**
 - Model/Voltage
 - Time/Pulse width (msec)
 - Energy (w-s, I, V, or P)
 - Heat profile

- Limit settings
- **Weld Transformer:**
 - Model
 - Tap Setting
- **Weld Head:**
 - Weld head model
 - Weld force (lbf, Kgf, dN)
 - Weld cable length
 - Weld cable diameter
 - Weld force verification frequency
- **Electrodes:**
 - Electrode polarity
 - Electrode alloys
 - Electrode dimensions
 - Electrode gap
 - Electrode cleaning and changing frequency
- **Test Parameters:**
 - Pull strength
 - Cross section depth
 - Weld monitor parameters
 - Sampling schedule
 - Cosmetic requirements

Spirit Of Innovation.

MIYACHI UNITEK

1820 S. Myrtle Ave. • P.O. Box 5033
Monrovia, CA 91017-7133 US • T: (626) 303-5676 • F: (626) 358-8048
info@muc.miyachi.com • www.miyachiuitek.com
ISO 9001 Certified Company • 24/7 Repair Service: 1-866-751-7378

MIYACHI

MIYACHI

MIYACHI

MIYACHI

follow us on:



MIDWEST Sales/Applications Lab:
50384 Dennis Ct., Wixom, MI 48393
T: 248 313 3078 • F: 248 313 3031
midwestsales@muc.miyachi.com

MEXICO Sales Office:
5959 Gateway West, Ste 327, El Paso, TX 79925
T: (915) 881-8765 • mxsales@muc.miyachi.com

ASIA Sales Office:
Unit D, 20/F, Infotech Centre, 21 Hung To Road
Kwun Tong, HK • T: +852 2833-6998
F: +852 2833-6672 • asiapacific@muc.miyachi.com

SOUTH ASIA Sales Office:
No 26, Sin Ming Lane, #04-125,
Midview City, 573971, SG
T: +82-31-8015-6810 • F: +82-31-8003-5995
T: +65 96318407 • southasia@muc.miyachi.com

Miyachi Corporation HQ -Tokyo, Japan
2-6-6 Motoasakusa Taito, Tokyo, 111-0041, JP
T:+81-3-5246-6700 • F:+81-3-5246-6890

Miyachi Europe GmbH
Lindberghstrasse 1 • DE-82178 Puchheim
T: +49 (0) 89 83 94 030 • F: +49 (0) 89 83 94 0310
www.miyachieurope.com • info@mec.miyachi.com

Miyachi Brazil:
Av. Ceci, 608 – Bloco 16B – Empresarial Tambooré,
06460-120, Barueri, SP, BR
T: +55 (11) 4193-1187
www.miyachibrasil.com.br
sasales@muc.miyachi.com

Miyachi Shanghai Corporation
Room 01,15th Floor, SML Center, No.610 Xujiahui
Road, Huangpu District, Shanghai 200025, CN
T:+86-21-6448-6000 • F:+86-21-6448-6550

Miyachi Taiwan Corporation
Rm.5, 2F., No.9, Dehui St., Zhongshan Dist.,
Taipei 10461, CN
T:+886-2-2585-0161 • F:+886-2-2585-0162

Miyachi Thailand Co. Ltd
40/14 Bangna Tower C, 17th Floor, Unit B, Moo 12,
T. Bangkaew, A. Bangplee, Samutprakarn 10540, TH
T:+66-2751-9337-8 • F:+66-2751-9340

Miyachi India Private Limited
No.23, Velvette House, Ground F, Dr. Ambedkar
Rd., Kodambakkam, Chennai, 600 024, IN
T:+91-44-4354-6814 • F:+91-44-4354-6816

Miyachi Korea Corporation
28, Dongtanhana 1-gil, Hwaseong-si,
Gyeonggi-do, 445320, KR
T:+82-31-8015-6810 • F:+82-31-8003-5995

Miyachi Vietnam Co., Ltd.
M floor, 400 Nguyen Thi Thap Street,
Tan Quy Ward, District 7, Ho Chi Minh City, VN
T:+84-8-3771-7972 • F:+84-8-3771-7974